

# Value Cool Tube

RFVACOOOL

## Assembly Instructions

### PARTS INCLUDED:

#### For hanging the Cool Tube:

- 1 Cool Tube
- 2 terminal connects
- 1 large screw
- 2 eye bolts
- 2 large nuts
- 3 large star washers
- 3 large washers

#### For adding on the Reflector:

- 2 metal straps
- 2 reflector strips
- 4 screws
- 4 small star washers
- 4 small washers
- 4 small nuts



**NOTE:** Remove protective overlay from specular insert before using.

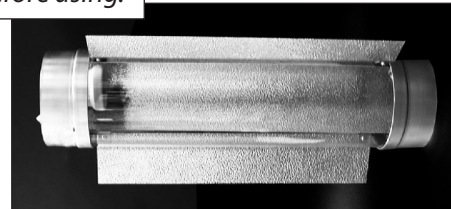

With the Cool Tube we recommend using a Hydrofarm 15' Lock & Seal Cord (CS53506) — not included.

#### To wire the Cool Tube:

(We recommend consulting a licensed electrician or shop that specializes in electrical work for proper wiring and plug changeover.)

- 1- Cut 90° molded end off of the power cord with wire cutters and re-strip wires. Then insert the exposed power cord wires through the rubber grommet and allow enough room to connect the ends. (See Illustration 1.)

- On the end of the green wire (the ground) should be a ring so that the unit can be grounded properly.
- If you do not have a ground terminal, use one of the ones provided.

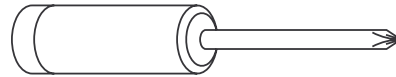
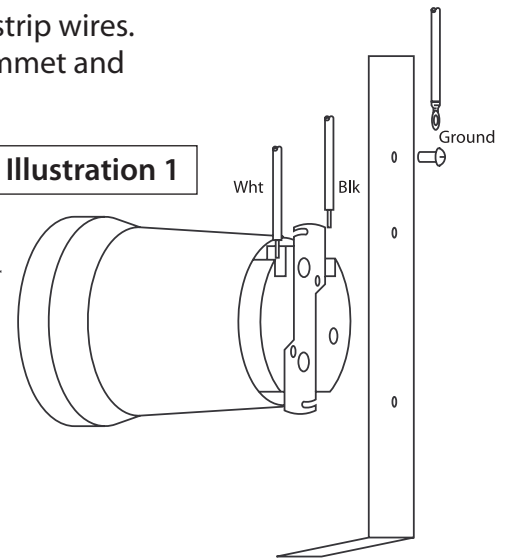

Illustration 1



- 2- Unscrew one of the screws that mount the socket to the "L" bracket and use the ground terminal (wire ring or the fork).
- 3- Insert the 2 other leads (black and white) into the proper terminals. From the inside of the socket tighten the screws so that the leads are firmly held in place.
- 4- Check to see if the unit works properly.

#### To hang the Cool Tube:

- 1- Clean the tube with window cleaner — or a similar product.
- 2- Take one of the eye bolts and screw a large nut half-way up the length of the bolt, then add a large star washer, followed by a large flat washer onto the bolt. (See Fig. A.) Now screw the bolt with the nut and the washers on it into the top holes of the Cool Tube until you have a snug fit. (See Fig. B.) This ensures a strong hanging point. Repeat for the other side.
- 3- Now insert HID bulb. It is important to keep the bulb clear of fingerprints.
- 4- Hang the Cool Tube.
- 5- Add the ducting to your unit. We suggest using a clamp (not included).

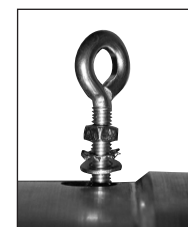

Figure A



Figure B

# Value Cool Tube

## Assembly Instructions - *continued*

### Assembly of add-on reflector:

- 1- The reflector strips can be attached in 2 different ways. Decide which angle best meets your needs. Figure C shows the strips attached for a wider distribution of light compared to Figure D, which concentrates the light down to a smaller space.
- 2- Take the metal strap with the open end facing down and insert one screw provided through the inside of the strap. Make sure the screw is pointing outward. Then take one of the reflector strips and insert the screw through the hole. Next, add one small star washer, one flat washer, and one small nut to the outside of the reflector and secure tightly. (See Fig. E.)
- 4- Repeat the previous steps for the other three holes.
- 5- Clip the reflector to the top of the Cool Tube so that the reflector is extended downward, concentrating the light to a single area.

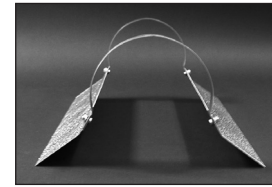

FIG. C

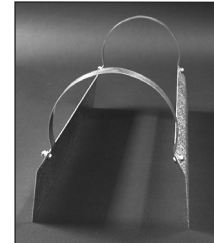

FIG. D

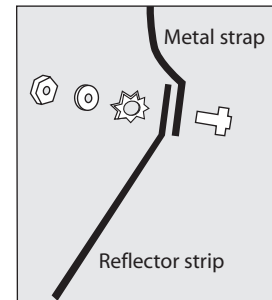

FIG. E